

НИКА/ NIKA

Код ТН ВЭД ЕАЭС

9403 60 100 1
9403 90 300 0



отрезать
и приклеить

1380	1550	406

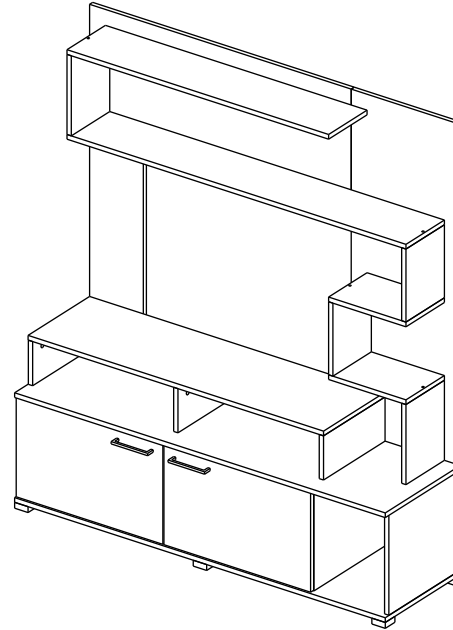
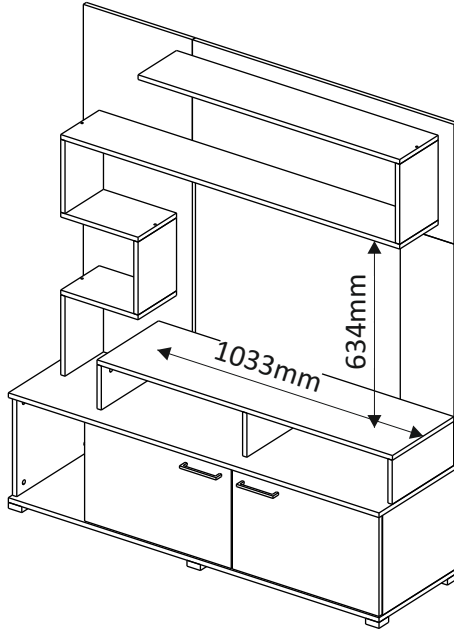

25ГНБЗ / 3247

Комплектовочная ведомость / Set package sheet

Упак/ Package	Наименование	Description	Цвет детали/ Décor	Размер / Size, mm	Кол-во/ Quantity	№
1	Крыша верх	Top upper	Craft gold	1380x406	1	11
	Крыша низ	Top lower	Craft gold	1380x406	1	12
	ХДФ	Back element	White	1376x370	1	18
	Крыша	Top	White	1100x320	1	10
	Крыша	Top	White	288x200	2	7
	Боковина	Side	Craft gold	340x386	2	5
	Боковина (петли)	Side (hinge)	Craft gold	340x386	2	6
	Крыша	Top	White	974x200	1	8
	Боковина лев	Side left	Craft gold	150x320	1	1
	Боковина прав	Side right	Craft gold	150x320	2	2
	Боковина	Side	Craft gold	272x200	2	4
	Задник	Back element	Craft gold	752x200	1	13
	Боковина	Side	Craft gold	248x200	2	3
	Крыша	Top	White	1262x200	1	9
2	Задник	Back element	Craft gold	1158x406	1	15
	Фурнитура	Furniture/Cabinetry hardware	-	-	-	-
	Створка	Door	White	546x336	2	16
	Задник	Back element	Craft gold	974x406	1	14

(PL) Instrukcja montażu

(CZ) Návod k montáži

(D) Montageanleitung

(GB) Assembly instruction

(F) Model d'emploi

(HU) Szerelési útmutató

(I) Istruzione di montaggio

(NL) Handleiding voor de montage



(RU) Инструкция по монтажу

(RO) Instrucțiuni de montare

(SK) Návod k montáži

(TR) Montaj talimatı

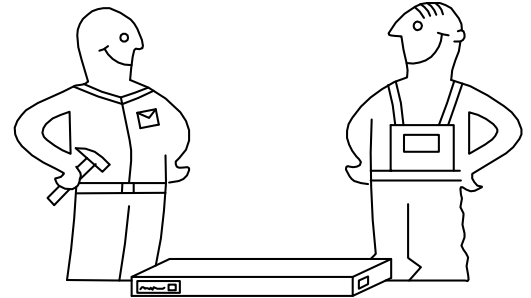
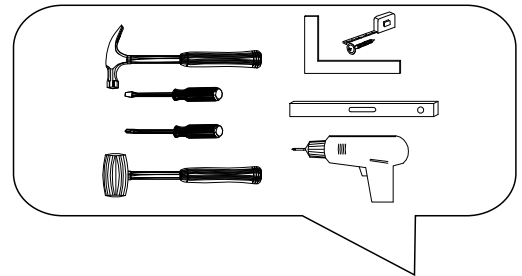



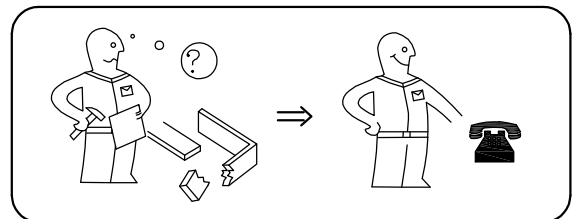
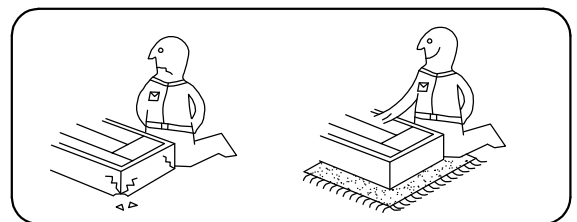



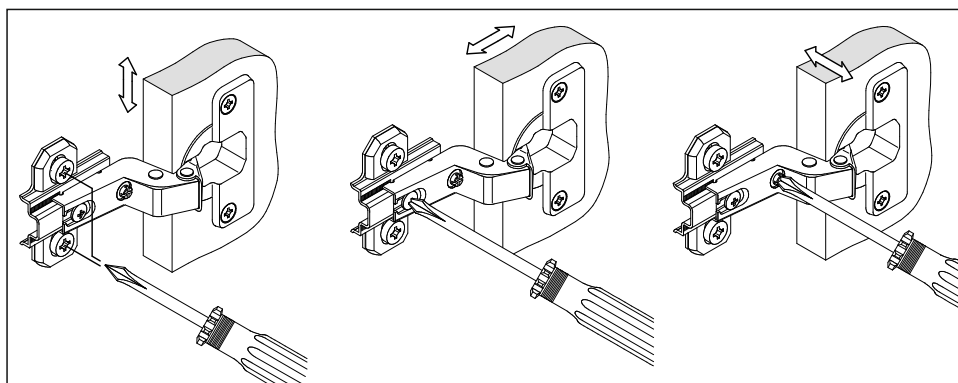
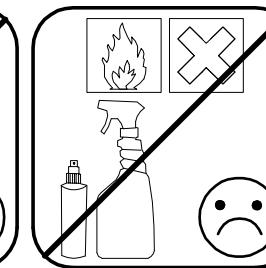
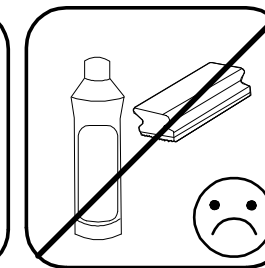
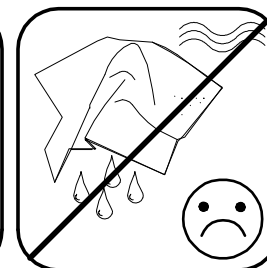
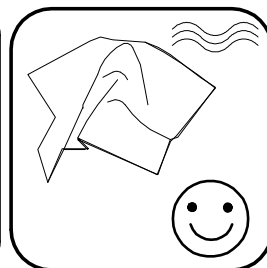
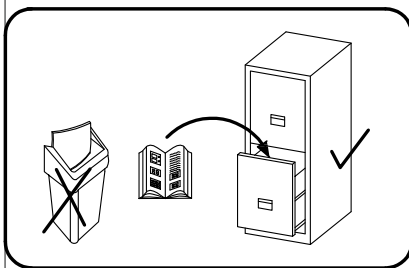

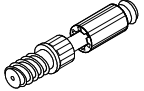
⚠ Uwaga • Upozornění • Achtung • Attention • Caution • Figyelem ⚠ Attenzione • Opgelet • Внимание • Atenție • Upozornenie • Dikkat	
PL	Czyszczenie należy wykonać wyłącznie za pomocą ściereczki lub lekko nawilżonego ręcznika. Nie stosować środków czyszczących do szorowania.
CZ	Čistění je nutné vykonávat výhradně pomocí utěrky nebo lehce navlhčeného ručníku. Nepoužívejte čističe obsahující abrazivní částice.
D	Bitte nur mit einem Staubtuch oder leicht feuchtem Lappen reinigen. Keine scheuernden Putzmittel verwenden.
GB	Please only clean with a duster or a damp cloth. Do not use any abrasive cleaners.
F	Le nettoyage se fait uniquement à l'aide d'un torchon ou d'une serviette légèrement mouillée.
HU	A tisztítás kizárólag törlőruha vagy enyhén nedvesített törölköző segítségével végezhető. Súroló hatású tisztítószerket nem szabad használni.
I	Pulire esclusivamente con un panno o un asciugamano umido.
NL	Reinig alleen met een stofdoek of een lichtjes vochtige doek. Gebruik geen schurende poetsmiddelen.
RU	Очищайте от пыли тряпкой или слегка влажной ветошью. Не допускается применение чистящих средств, не предназначенных для ухода за мебелью.
RO	Curățarea trebuie efectuată numai cu o cârpă sau cu un prosop ușor umezit. Nu utilizați agenți de curățare abrazivi.
SK	Čistení je nutné vykonávať výhradne pomocí utierky alebo ľahko zvlhnutým ručníkom. Nepoužívajte čistiace prostriedky obsahujúce abrazívne častice.
TR	Lütfen sadece bir toz bezilye veya hafif nemli yumuşak bir bezle siliniz. Aşındırıcı temizlik malzemeleri kullanmayınız.

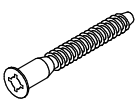

**Karta serwisowa • Servisní list • Service Karte • Service card • Carte de service • Szervizkártya
Scheda di servizio • Service kaart • Сервисная карта • Fisa service • Servisný list • Servis karti**

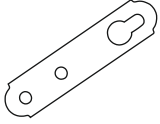
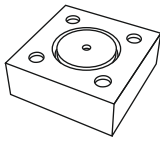
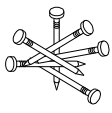
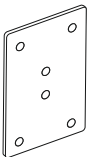

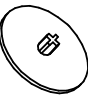
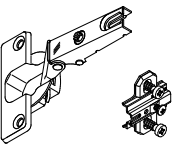
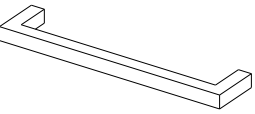
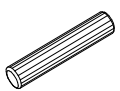
1		2		5	7x50	6	6,3x10,5	15	
									
22 x		22 x		30 x		8 x		1 x	
18	3,5x15	27		38		48	2x20	50	
									
60 x		2 x		6 x		20 x		3 x	
71	∅ 5 mm	72		73		91	Hinge A	126	C42 128 mm
									
3 x		7 x		22 x		4 x		2 x	
7	8x30								
									
4 x									

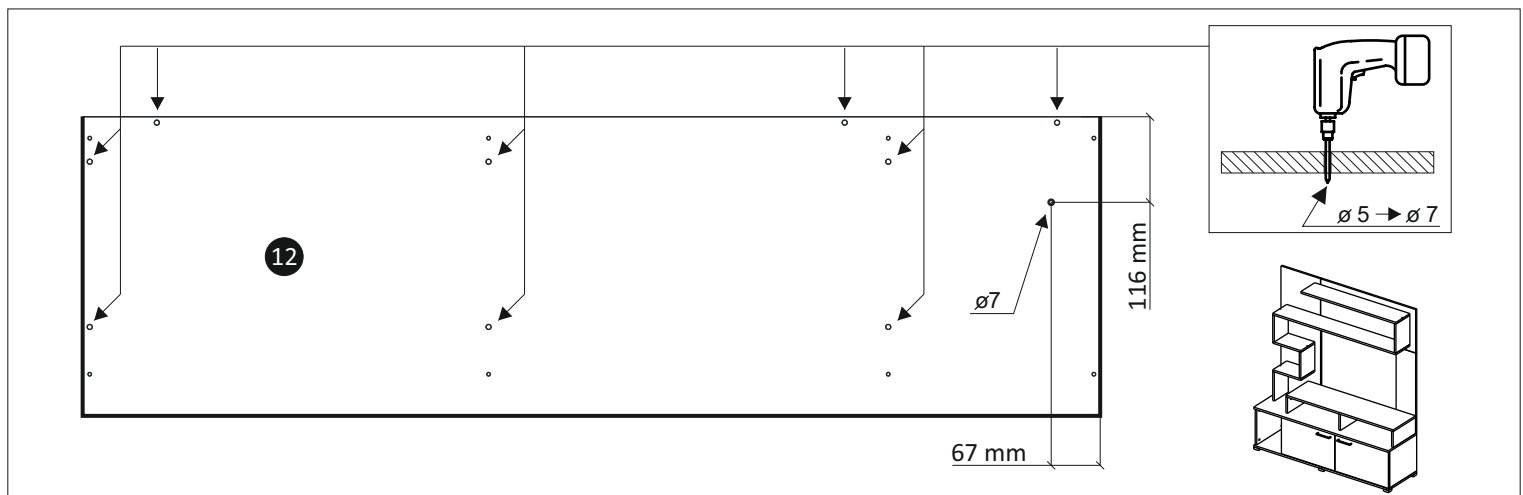
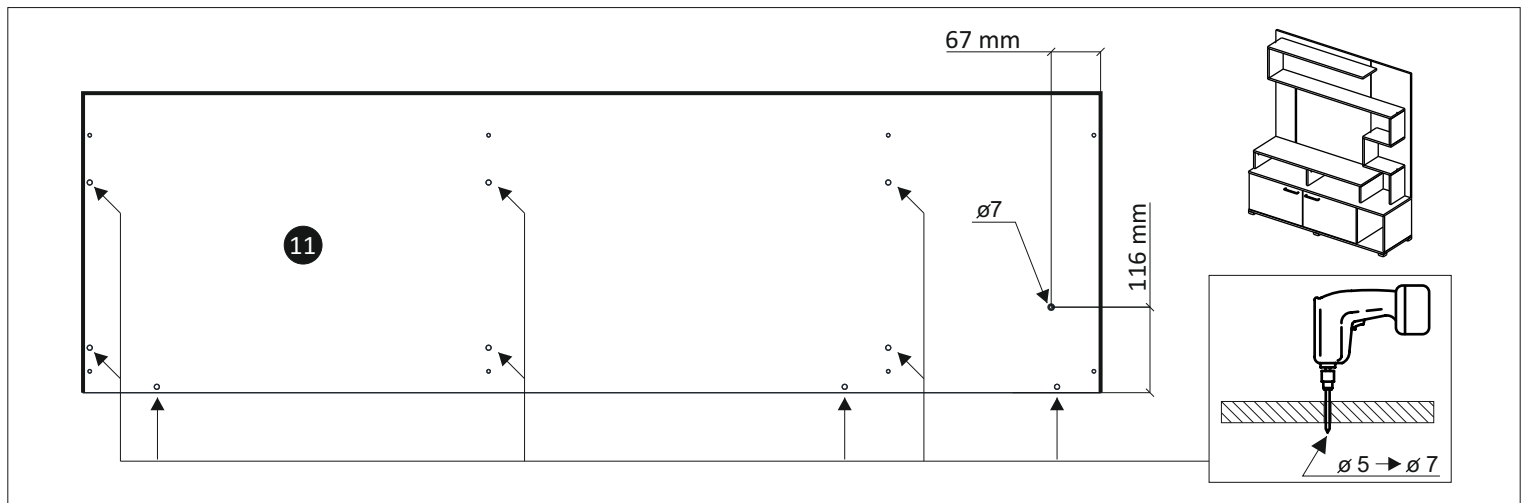

4

